

available:

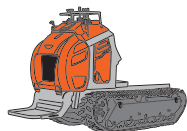

C1150
1150 kg

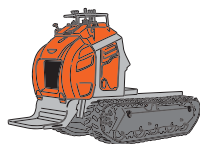

C1200
1200 kg

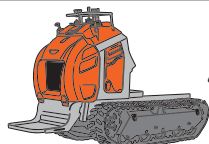

C1300
1300 kg

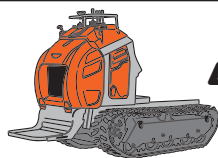

C1350
1350 kg

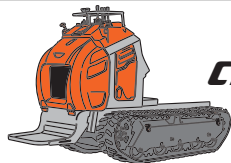

C1400
1400 kg

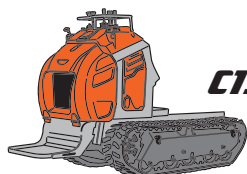

C1500
1500 kg

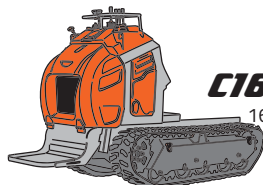

C1600
1600 kg



KIT MINI CARICATORE
MINI LOADER KIT

AUTOLIVELLANTE
AUTOLEVELLING

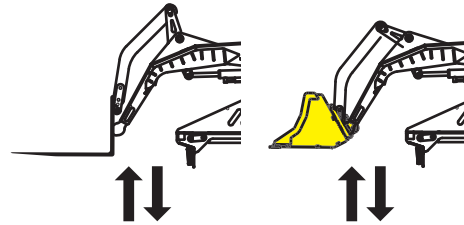
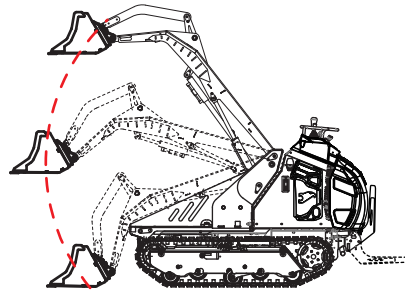
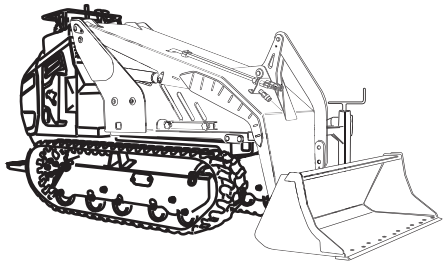

AUTOLIVELLANTE
AUTOLEVELLING

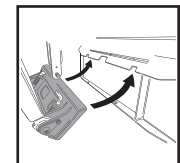

ATTACCO RAPIDO ACCESSORI
quick attach attachments

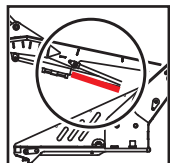

SUPPORTO SICUREZZA
safety support

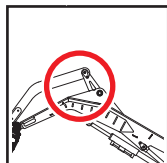

REG. ANGOLO BENNA
BUCKET ANGLE ADJ.

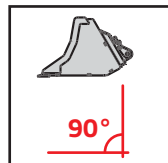

AUTOLIVELLANTE
auto leveling

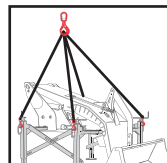

SOLLEVABILE
liftable

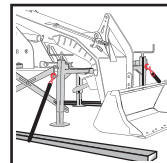

TRASPORTABILE
transportable

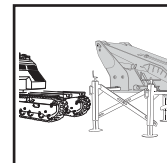

QUICK ATTACH

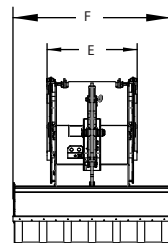
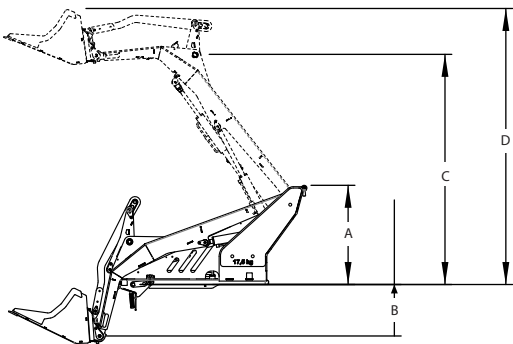

C1150 - C1200		C1300 - C1350 - C1400 - C1500 - C1600	
mm	in	mm	in
A	728	28.7	
B	378	14.9	
C	1688	66.5	
D	2025	79.7	
E	597	23.5	
F	1050	41.3	

C1150 - C1200

CARICO DI RIB./TIPPING LOAD	
senza contrappeso	con contrappeso (210kg 462lb)
857 KG 1867 LB	996 KG 2195 LB
CAPACITÀ DI RIB./TIPPING CAPACITY SAE 50%	
senza contrappeso	con contrappeso (210kg 462lb)
429 KG 934 LB	498 KG 1098 LB
CAPACITÀ DI RIB./TIPPING CAPACITY SAE 35%	
senza contrappeso	con contrappeso (210kg 462lb)
300 KG 661 LB	348 KG 768 LB
PESO/DRY WEIGHT	
senza contrappeso	con contrappeso (210kg 462lb)
281 KG 619 LB	491 KG 1081 LB

C1300 - C1350
C1400 - C1500 - C1600

CARICO DI RIB./TIPPING LOAD	
senza contrappeso	con contrappeso (210kg 462lb)
994 KG 2191 LB	1150 KG 2535 LB
CAPACITÀ DI RIB./TIPPING CAPACITY SAE 50%	
senza contrappeso	con contrappeso (210kg 462lb)
497 KG 1096 LB	575 KG 1268 LB
CAPACITÀ DI RIB./TIPPING CAPACITY SAE 35%	
senza contrappeso	con contrappeso (210kg 462lb)
348 KG 767 LB	403 KG 888 LB
PESO/DRY WEIGHT	
senza contrappeso	con contrappeso (210kg 462lb)
330 KG 728 LB	540 KG 1190 LB